

KOVACS

DESIGN FURNITURE



VOLUME 04

**MADE.[®]
RIGHT.
HERE.**

INVEST IN QUALITY NEW ZEALAND MADE FURNITURE
THAT'S MADE BY HAND AND KNOWN BY HEART.



KOVACS
DESIGN FURNITURE

® Registered Trademark of Kovacs Design Furniture Limited

FREYA MODULAR LOUNGE
AND GEO TABLES



FRONT COVER:
Bronx Modular Lounge,
Geo Oblong Coffee Table,
Rox Ottoman

BACK COVER:
Mantis Chair

Welcome to our Kovacs
Catalogue, Volume 4!

Please browse our range here
and check for more information
and new designs throughout
the year on our website.

kovacs.co.nz

CONTACT INFO

**KOVACS DESIGN FURNITURE - FACTORY,
ADMINISTRATION & TRADE SHOWROOM**

1000 Ferry Road
Ferrymead
Christchurch 8023
New Zealand

Phone: 03 384 2999

Email: info@kovacs.co.nz or
vashti.hammond@kovacs.co.nz

Trade showroom open weekdays,
viewing by appointment

KOVACS AUCKLAND TRADE SHOWROOM

159 Design
159 Great North Road,
Grey Lynn
Auckland 1021

Phone: Samantha Hurd 027 493 6004

Email: samm.hurd@kovacs.co.nz

WELLINGTON DESIGN LIBRARY

282 Thorndon Quay
Wellington Central
Wellington 6141

Phone: 04 471 2800

Email: info@wellingtondesignlibrary.co.nz

KOVACS
DESIGN FURNITURE



CONTENTS

- 11 LOUNGE
- 27 MODULAR LOUNGE
- 55 CHAIRS
- 68 RECLINER LOUNGE
- 75 HARD FURNITURE
- 80 OTTOMANS
- 84 Sustainability
- 85 Wool
- 86 Our history
- 88 Index
- 89 Our stockists



**KOVACS MANUFACTURED PRODUCTS ARE
AVAILABLE FROM SELECT STOCKISTS AND DESIGN
PROFESSIONALS THROUGHOUT NEW ZEALAND.**

**LINCOLN SETTEE, TANGO CHAIR
AND GEO TABLES**



LENNOX SETTEE AND
ROX OTTOMAN



BERTIE MODULAR, MARLEY
CHAIR AND MASON TABLE



BROOKLYN SETTEE

LOUNGE

Gone are the days when lounge furniture would be replaced after a few years. Nowadays we demand more and, given the investment in quality and the need for sustainability, well we should. This furniture should maintain both style and comfort across generations. And that's what our work always aims to deliver – furniture that is functional, adaptable, and, from year to year, beautiful.

AXLE

Named for the robust steel frame at its heart, the Axle is a minimalist masterpiece with complex attraction. Simple and masculine in form, the imposing steel frame is striking from a distance while providing industrial strength in functionality. This frame sets up a surprising contrast to the comforting lines of the cushioning, which combines feather and foam. The feather-filled arms create a plush, pliable surface to sink into which, together with the crafted seat and back, brings you a new level of comfort. Although it seems incongruous, the Axle really is strong and soft at the same time. It's a blend of the qualities most valued by Kovacs.

DIMENSIONS (CM)	WIDTH	DEPTH	HEIGHT
Chair	101	92	81
2.5 Seater	185	92	81
3 Seater	217	92	81
3.5 Seater	240	92	81
Seat height			46



BROOKLYN

The Brooklyn's peaceful symmetry and astute simplicity allow it to sit easily in apartments or open spaces. A low back and level arms keep the silhouette compact and tight upholstery ensures a neat appearance over time with both fabric and leather as options. The slim plinth adds finer detail to an otherwise substantial piece and balances the circular elements with contrasting angles. Wooden legs, long and tapered, elevate and soften the profile. With a sturdy Southland beech frame, reinforced by steel in the two larger sizes, the shape is designed to last. In a world where extremes are easy and design is disposable, the Brooklyn stands out as a study in composure and balance.

DIMENSIONS (CM)	WIDTH	DEPTH	HEIGHT
2 Seater	153	85	71
2.5 Seater	181	85	71
3 Seater	213	85	71
3.5 Seater	236	85	71
OT20 Ottoman	110	70	40
Seat height			45





CLUB 2 SEATER SETTEE

CLUB

Specifically designed for apartment living, the medium height Club provides generous seat depth and width without overpowering any space. Available as a chair and settee in multiple widths, the Club can be covered in either fabric or leather. When upholstered in leather the standard saddle trim stitching uses a matching colour to add strength and character.

DIMENSIONS (CM)	WIDTH	DEPTH	HEIGHT
Chair	92	88	83
2 Seater	146	88	83
2.5 Seater	187	88	83
3 Seater	206	88	83
Seat height			48



GIBBSTON

The rugged, elemental base and tranquil backdrop of Gibbston Valley provided all the inspiration needed for this settee and chair design. Just like the renowned grape-growing destination so too does this model look alluring from every angle, the elegant curved back ensuring it can settle down into the background or stand out in the middle of the room. Quality construction makes the difference, pre-bent and straight steel components creating shape and strength while allowing cushioning and other design elements to combine with grace and style. Plush and bold without being too flashy or 'of-the-now', the Gibbston, like a good vintage, will reward those in the years to come.

DIMENSIONS (CM)	WIDTH	DEPTH	HEIGHT
Chair	105	94	86
2.5 Seater	181	94	86
3 Seater	213	94	86
3.5 Seater	236	94	86
Seat height			48



GRACE

Sophisticated and sumptuous, retrospective and romantic, the Grace is undoubtedly an investment in refinement. While bold and effortless in bearing, closer inspection of the Grace uncovers clever little details. Along with the careful balance between authoritative lines and enticing curves the octagonal tapered legs provide a distinct look and lightness of manner. Three different densities of seat foam and two in the back deliver plush comfort and hours of luxurious repose. The craft of artisan furniture design is about such details. In the Grace such craft is at its pinnacle. Available in a plain non-fluted back and seat option.

DIMENSIONS (CM)	WIDTH	DEPTH	HEIGHT
Chair	87	86	73
2 Seater	137	86	73
2.5 Seater	165	86	73
3 Seater	196	86	73
4 Seater	242	86	73
Seat height			44





GIBBSTON LOUNGE,
MASON CIRCULAR TABLE



HENDRIX SETTEE, GEO TABLES
AND BRUNA SHELVING UNIT



HEATH 3 SEATER SETTEE

HEATH

With a smaller than expected footprint and plush cushioning the Heath shares a family resemblance to the Bronte. This is an earthy piece, a snug, comforting couch. With a narrow frame it is also an excellent and efficient use of space. The design can define a space without dominating it. The eight-sided leg and simple lines ensure it looks great from all angles. The layered foam of the seat cushion, deep soft side and luxurious back cushioning sends out an invitation to nestle. The Heath blends into any environment – the timeless form and long-lasting comfort will keep this piece fresh for years to come. Now available with removable body covers.

DIMENSIONS (CM)	WIDTH	DEPTH	HEIGHT
Chair	98	92	76
2.5 Seater	176	92	76
3 Seater	208	92	76
3.5 Seater	231	92	76
Seat height			44



HENDRIX

Designed for ultimate comfort, the abundant, voluptuous curves of the Hendrix complement its 'bold as love' stability. The performance of this piece must be appreciated up close. Delivering perfectly balanced proportions, the design delivers sound, generous stability and invites time in blissful relaxation. Deep seating with an ergo filled cushioning gives this piece integrity while uniquely angled wooden legs add a touch of nostalgic charm. Thoughtful and refined, with softly curved arms and a rounded back hinting at yesteryear, it never compromises a single note of style. With this solid, contoured form it looks best as either a 3 or 3.5 seater, the bold silhouette merging well with both mid-century furnishings and contemporary interior design.

DIMENSIONS (CM)	WIDTH	DEPTH	HEIGHT
2.5 Seater	187	110	72
3 Seater	210	110	72
3.5 Seater	251.5	110	72
Seat height			44.5



HENLEY

The design of the Henley delivers from-the-past glamour and in-the-now sophistication. This is a transitional piece, designed to sit equally well in a century-old wooden-floored bungalow or a sleek, ultra-modern setting. The English rolled-arm style, wide and accentuated with a defined outward roll, creates the spacious feeling the style is known for. The thick seat cushions are contoured for maximum comfort. Additional elements place the design firmly in the present day. The balanced proportions of the steel base provide an efficient solidity and easy compatibility with other modern pieces. As an alternative option we have created a tall turned leg to further the turn-of-the-century feel.

DIMENSIONS (CM)	WIDTH	DEPTH	HEIGHT
2.5 Seater	190	95	72
3 Seater	222	95	72
3.5 Seater	245	95	72
Ottoman	95	68	43.5
Seat height			44



JED

Classic, clean and contemporary, the Jed's simplicity of design belies its focused bearing and clever adaptability. Sitting upon a timber or steel plinth base Jed may at first seem angular, even severe. But that potential sharpness is circumvented with edges softened by gentle curves and the careful balance overall of aesthetic appeal and physical comfort. This provides a fresh settee with confident simplicity and style. Wide arms and the charcoal coloured steel base are standard. Both a timber base and narrow arms are options. Devised to suit any number of coverings, makes the Jed a truly versatile piece suiting both residential and commercial spaces.

DIMENSIONS (CM)	WIDTH	DEPTH	HEIGHT
Chair	82/104*	82	79
2 Seater	139/161*	82	79
2.5 Seater	163/185*	82	79
3 Seater	195/217*	82	79
3.5 Seater	228/250*	82	79
OT22 Ottoman	71	65	43.5
OT23 Ottoman	95	68	43.5
Seat height			43.5

wider arm*



JIGSAW

The Jigsaw is a compact settee with a stylish, contemporary feel. Its proportions are low and sleek with slim arms allowing maximum seating comfort while keeping the Jigsaw foot print to a minimum. The beauty and versatility of this design is a discrete yet functional feature...the back cushions are shaped to be easily raised giving extra seat depth and back height to support shoulders. The highly resilient back cushions offer the ultimate combination of comfort and practicality. Together with the commercial grade seat foam and suspension, luxurious seating is ensured. The original finely proportioned arms are now available in a slightly wider option that adds 8cm to the overall width of each settee/ chair, both are well padded to add to your overall comfort, a round bolster is standard or there is an option of a side cushion. The Jigsaw has, at its core, a solidly built frame that will provide years of enjoyment.

DIMENSIONS (CM)	WIDTH	DEPTH	HEIGHT
Chair	89	98	73/89*
2.5 Seater	162	98	73/89*
3 Seater	194	98	73/89*
3.5 Seater	217	98	73/89*
4 Seater	240	98	73/89*
Seat height			50

headrest up*



LINCOLN

With bold styling and solid construction the Lincoln evokes a classical approach to furniture design – the look of yesteryear, updated for the here and now. As with the original chesterfield, the deep buttoning and upright bearing provides an enduring sense of sophistication. However the Lincoln goes beyond its influences, which results in a settee suitable for everything from enhancing the small apartment to refining the upmarket hotel suite. Seat cushions also available using Ergofill as an option.

DIMENSIONS (CM)	WIDTH	DEPTH	HEIGHT
Chair	92	85	74.5
2 Seater	145	85	74.5
3 Seater	200	85	74.5
4 Seater	246	85	74.5
Seat height			46



LOFT

Furniture should work from every angle, and filling a functional, physical and aesthetic role from any perspective can be difficult. That's why we're so proud of the Loft. At once inviting, enchanting and unexpected, the settee is somewhat of a visual contradiction – a sturdy, grounded and enduring piece that also appears to gracefully float above its surroundings. With captivating design appeal from all angles the Loft's clean, efficient lines provide room to stretch out and the highest quality commercial foam entices you to do so.

DIMENSIONS (CM)	WIDTH	DEPTH	HEIGHT
3 Seater	213	100	76
3.5 Seater	245	100	76
Seat height			46



MAX

Good design is as much about what's left out as what's included. For the Max this balance is crucial – the understated style and clean efficiencies providing classic modernist style with a twist. If there's one thing it is, it's more than 'one thing', a hinged back cleverly engineered to extend influence and functionality. Rather than imposing itself the Max compliments the surrounding space – it's at home as much in the small apartment as it is the family living room or the concrete-floored loft space. While the wide arm is anchored with a timber slab foot keeping the profile low and solid, the narrow arm version looks sleek on a contemporary metal 'stiletto' foot, brushed silver or black, and provides a more compact footprint.

DIMENSIONS (CM)	WIDTH	DEPTH	HEIGHT
2.5 Seater	171/195*	95	70/89**
3 Seater	196/220*	95	70/89**
3.5 Seater	220/244*	95	70/89**
Seat height			44

wider arm* headrest up**

Aluminium or oak leg options add 3cm to heights



SIMPLICITY

This chair and settee are built for utter relaxation. The raw charm and relaxed, generous proportions provides a sense of lavish comfort and, while appearing oversized, the settee actually sits within a very compact footprint. Built for two, the chair is a love seat in every sense. At Kovacs we love the versatility of the Simplicity, it's design echoing traditional style while utilising the best of modern material and technique. Perfect for all types of family living, particularly with the peace of mind of removable covers, the Simplicity is comfort made simple – and simple made perfect.

DIMENSIONS (CM)	WIDTH	DEPTH	HEIGHT
Chair	114	102	94
2.5 Seater	161	102	94
3 Seater	193	102	94
3.5 Seater	216	102	94
Seat height			48





JIGSAW SETTEE, GEO SIDE
AND COFFEE TABLE



SIMPLICITY LOUNGE AND
GEO COFFEE TABLE

MODULAR LOUNGE

A good modular suite encourages life to expand and contract around it. It should work both as an island for laid-back solitude and, when the occasion calls for it, as a gathering point for connection and conversation. With such an important range of use, a modular lounge needs to offer adaptability and durability. With thoughtful design and timeless style, our pieces deliver such enduring service with aplomb.



BERTIE MODULAR LOUNGE



BERTIE

Yes, the Bertie is big and bold. However, with elegant lines and constrained cushioning providing an understated and considered aesthetic, so too is it surprisingly compact when viewed in person. At home amongst the modernist architectural movement, the Bertie fits beautifully among a palette of timber, concrete and metal tones. This modular lounge is not dramatic or ostentatious. Rather it is composed and clean-cut, with a comforting angular quality balanced by small details such as the inward curve of the backrest. In this way it can step beyond the realm of stark minimalism and into a world of depth and functional style. Fine metal legs are balanced against the sumptuous upholstery, which is backed by a built to last framing structure and commercial quality foam.

DIMENSIONS (CM)	WIDTH	DEPTH	HEIGHT
2.5 Seater Settee	231	91	71
3 Seater Settee	257	91	71
3.5 Seater Settee	280	91	71
End Unit Triple (LH/RH arm)	227	91	71
End Unit Twin (LH/RH arm)	163	91	71
Triple Chaise (LH/RH chaise)	292	91	71
Twin Chaise (LH/RH chaise)	228	91	71
Seat height			44
Seat depth (without lumbar cushion)		59	
Lumbar Cushion (optional)	66	30	7.5
Side Arm Cushion (optional)	55	30	7.5



BERTIE SETTEES

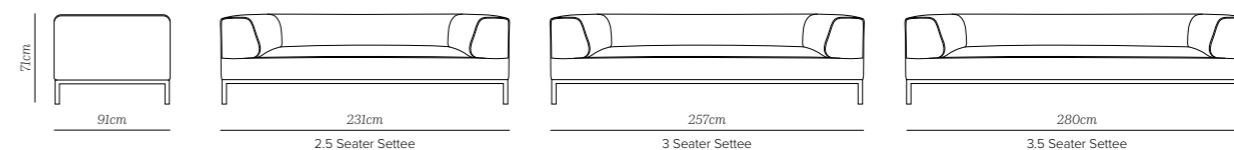

BERTIE END UNITS / LEFT OR RIGHT ARM

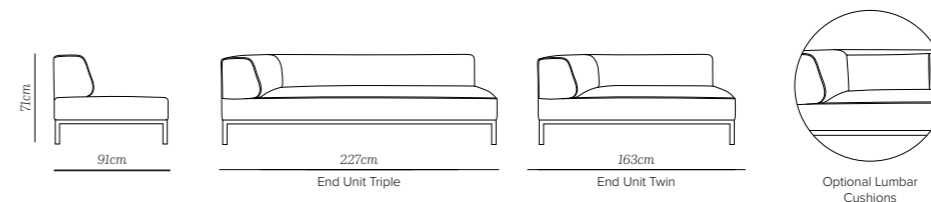

BERTIE CHAISE / LEFT OR RIGHT ARM

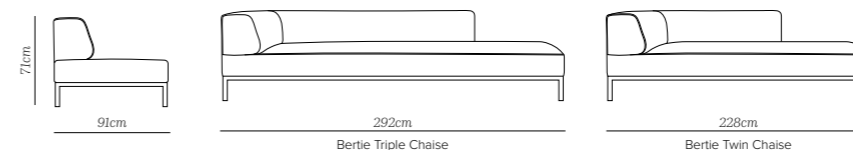



BRONTE

Take a seat on the hugely comfortable Bronte and enjoy the plush, enveloping support. Put your feet up with a book and drink nearby and you'll never want to leave. In the words of the designer, this is the "ergonomically correct slouch-couch", the perfectly layered foam capable of satisfying even the most discerning. The modular elements also provide layout flexibility and the construction materials durable integrity through the years. It's all without compromise in style too, with contemporary lines and careful stitching providing a modern look that is aesthetically pleasing to the eye. Choose from the extensive range of units to create your perfect adaptable layout - you can now also choose a wider arm option.

DIMENSIONS (CM)

	WIDTH	DEPTH	HEIGHT
Chair Standard	83.5/89.5*	92	85
Chair Large	97/103*	92	85
2.5 Seater Settee	156/162*	92	85
3 Seater Settee	181/187*	92	85
3.5 Seater Settee	206/212*	92	85
Straight Unit Single Standard (no arms)	75.5	92	85
Straight Unit Single Large (no arms)	88	92	85
Straight Unit Twin Standard (no arms)	148	92	85
Straight Unit Twin Large (no arms)	173	92	85
End Unit Twin Standard (LH/RH arm)	151/154*	92	85
End Unit Twin Large (LH/RH arm)	177/180*	92	85
Corner Unit	90.5	90.5	85
Ottoman	92	92	47
Seat height			47
Side Arm Cushion	70	50	
		wider arm*	

BRONTE CHAIRS AND SETTEES

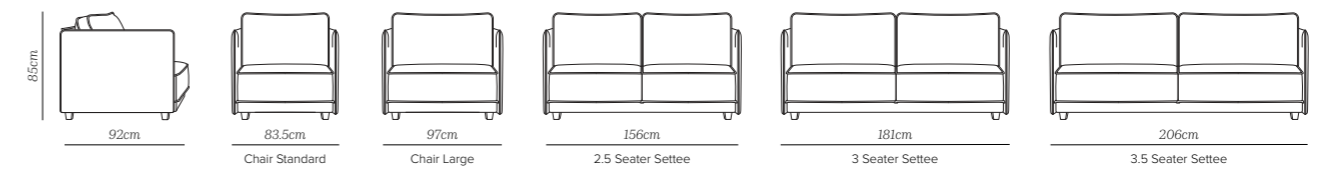

BRONTE END UNITS / LEFT OR RIGHT ARM

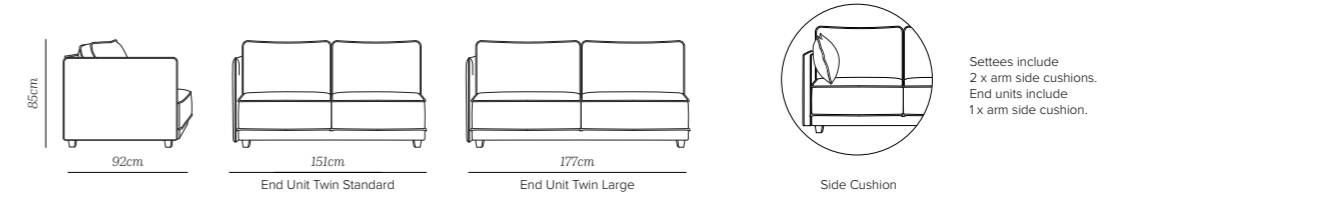

BRONTE CHAIRS AND SETTEES WIDER ARM

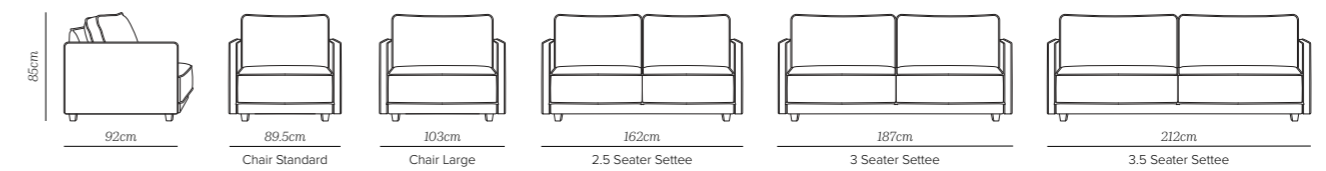

BRONTE END UNITS WIDER ARM / LEFT OR RIGHT ARM

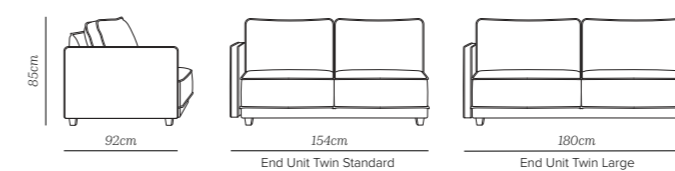

BRONTE STRAIGHT UNITS

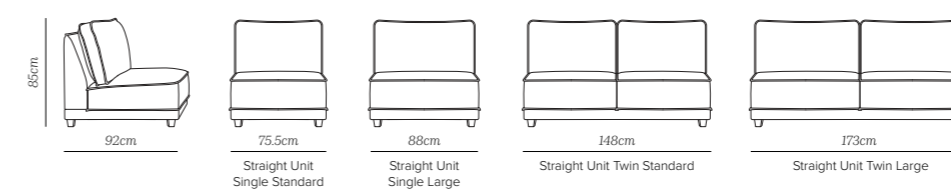

BRONTE CORNER UNIT AND OTTOMAN

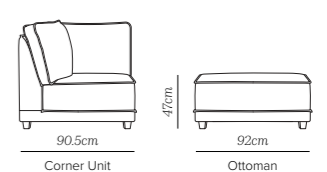



BRONX MODULAR LOUNGE,
ROX OTTOMAN, GEO TABLE



BRONX

With a touch of New York grit and enticing curves, the Bronx confidently offers big city sophistication and enduring style. It begins in its bones, where powder coated steel framing elevates the piece. Clean lines are accentuated by a slim line back profile bolstered by deep cushioning. Tufted seats provide lux support and add refined texture. Like most enduring designs, the simplicity of this modular suite is deceptive. Hours of thought and effort have gone into the uniquely refined profile and upholstery. It's resulted in a piece perfect for those who appreciate a little luxury and a lot of comfort. Available in a variety of sizes and a range of fabrics and metal finishes. The Bronx, not only timeless and well engineered but also blissfully comfortable.

DIMENSIONS (CM)

Chair High Narrow Arms	102	95	90
3 Seater Settee	183*/222**	95	90
3.5 Seater Settee	210*/249**	95	90
End Unit Twin (LH/RH arm)	175*/194**	95	90
End Unit Single (LH/RH arm)	93*/112**	95	90
Straight Twin Chaise (LH/RH chaise)	221	95	90
Straight Single Chaise (LH/RH chaise)	139	95	90
Straight Twin (no arms)	166	95	90
Straight Single (no arms)	83	95	90
Corner Unit	95	95	90
Seat height			44
Side Arm Cushion (optional with narrow arm)	50	27	5

high narrow arm* low wide arm**

BRONX CHAIR AND SETTEES HIGH NARROW ARM

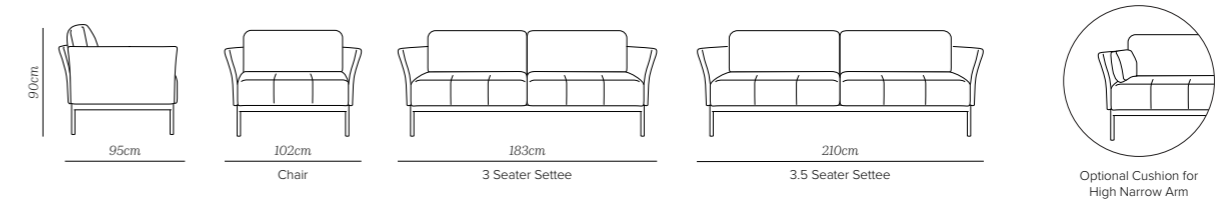

BRONX END UNITS HIGH NARROW ARM / LEFT OR RIGHT ARM

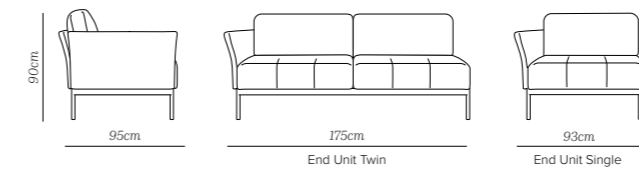

BRONX CORNER UNIT

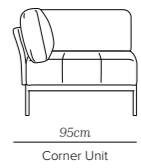

BRONX SETTEES LOW WIDE ARM

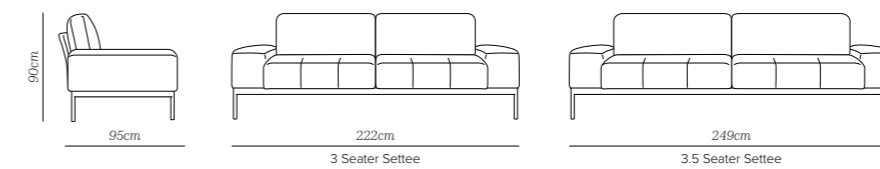

BRONX END UNITS LOW WIDE ARM / LEFT OR RIGHT ARM

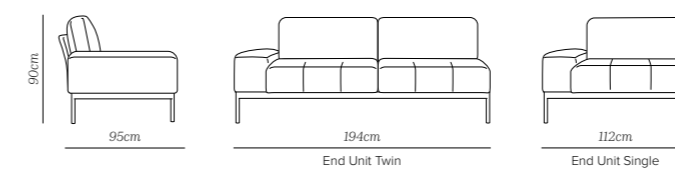

BRONX STRAIGHT UNITS / LEFT OR RIGHT CHAISE

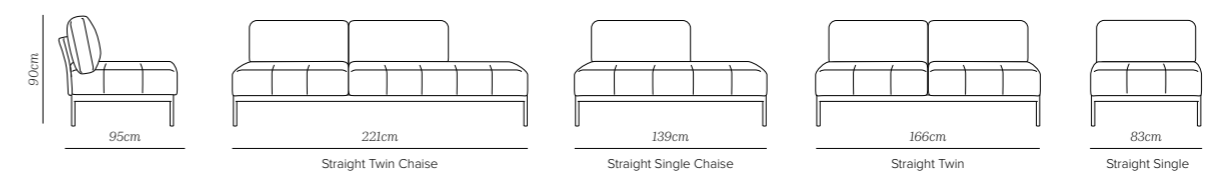



COMBI MODULAR LOUNGE



DETROIT

Technically complex and elegantly stylish, the Detroit is an architectural piece that's up to date, above the standard and beyond the everyday. While the lines evoke the Loft this settee has an elegant handwriting all its own. The arms are refined, the back filed in, the seat cushioning wraps around and, when necessary, rises up. With solid beech, adaptable MDF and robust steel construction the design is sleek yet strong. Change the combination of fabric and leg colour, and it will fit into any interior environment with succinct, enduring solidity. For 'floating above' European sophistication and at-home functionality the Detroit rises to the occasion. Available with a brushed silver or matt black metal leg option.

DIMENSIONS (CM)	WIDTH	DEPTH	HEIGHT
2.5 Seater	187	94	70/89*
3 Seater	212	94	70/89*
3.5 Seater	237	94	70/89*
End Unit Single (LH/RH arm)	107	94	70/89*
End Unit Twin (LH/RH arm)	190	94	70/89*
Chaise Unit Single (LH/RH arm)	107	139	70/89*
Seat height			44
			headrest up*

DETROIT SETTEES

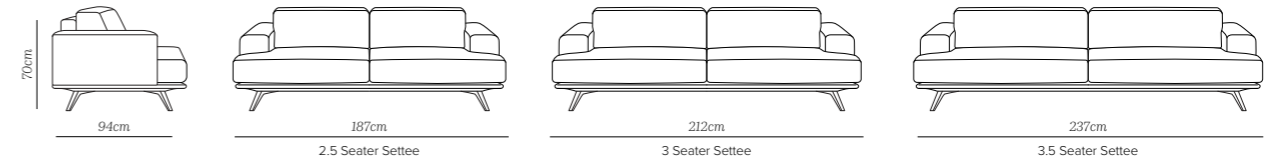

DETROIT END UNITS / LEFT OR RIGHT ARM

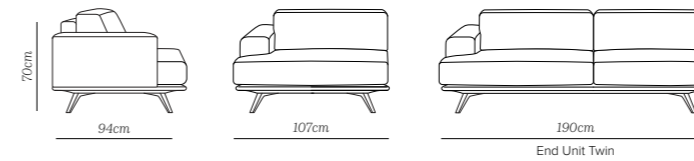

DETROIT CHAISE / LEFT OR RIGHT ARM

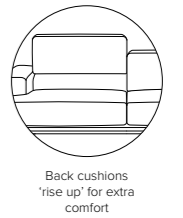
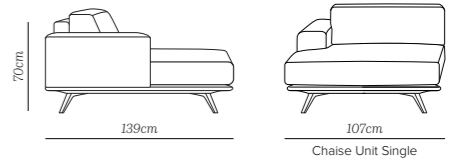

COMBI

Mix sections, match style, build your Combi. With innovative weighted backs and corner sections this unique range redefines the lounge suite with a sophisticated and adaptable approach to modular seating. The Combi suits both indoor, outdoor and commercial uses and while ideal for seating it is easily rearranged for lounging. Tetris players will certainly love it – not only is it reminiscent of the classic computer game, the Combi can provide just as much joy in its configuration possibilities.

DIMENSIONS (CM)	WIDTH	DEPTH	HEIGHT
Base Ottoman A	87.5	87.5	22
Base Twin A	87.5	87.5	44
Base Ottoman B	126	87.5	22
Base Twin B	126	87.5	44
Back Straight A	30	87.5	30
Back End/Corner A	87.5	87.5	30

COMBI COMPONENTS

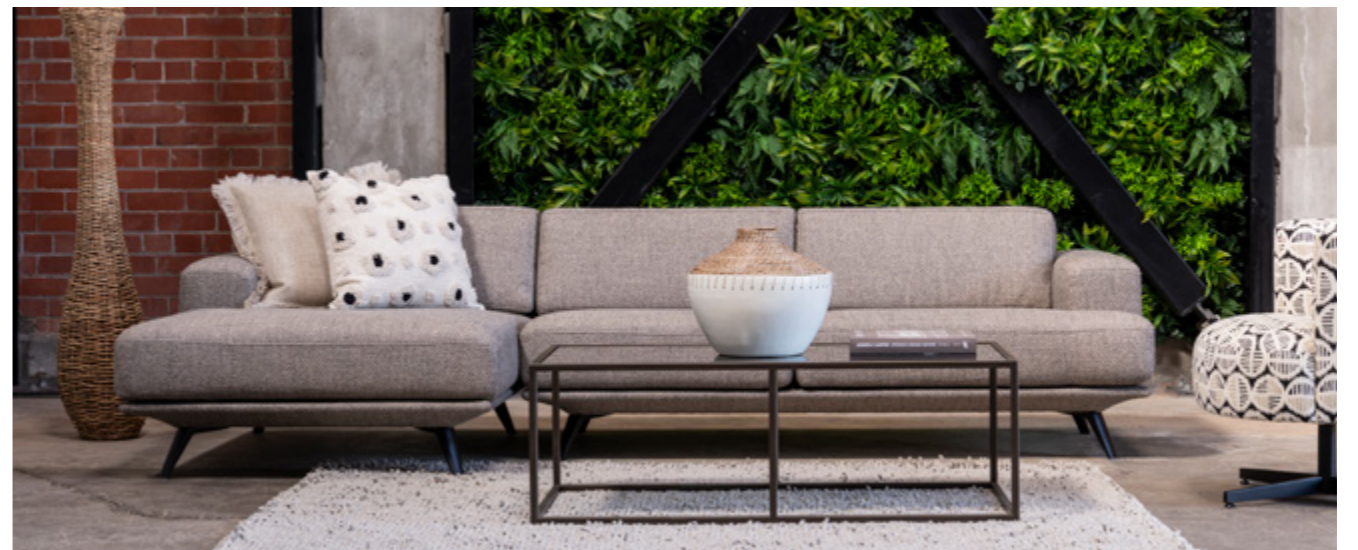
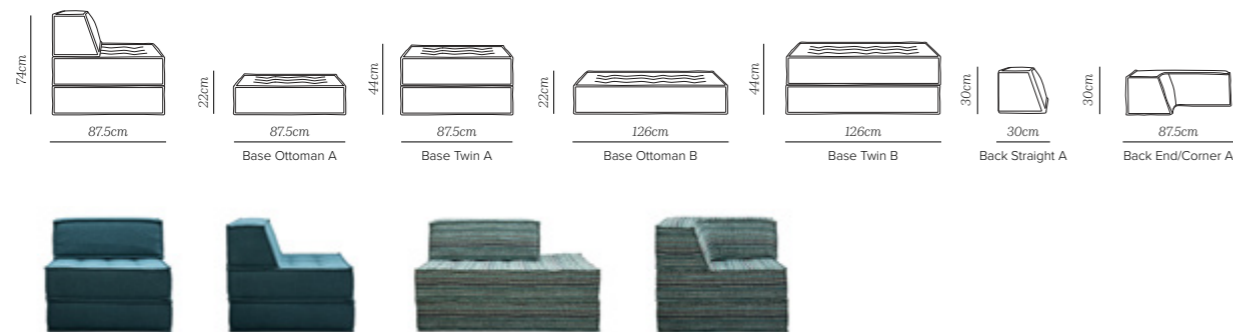



ELEMENTS

This is a design that is both expansive in style and personalised in use. Elements provides a distinctive approach to assembly, both the arms and backs are interchangeable and are able to be moved and locked to the base unit. Creative buttoning and supple, supportive and luxurious cushioning make the overall aesthetic a dream-like one. You can both add to and adapt Elements to suit any environment, being able to evolve a major piece of furniture is a considerable advantage. Interesting colours and fabric choices provide another chance to create a bold individual design statement without compromising ongoing comfort. Now versatile and enduring style is elementary.

DIMENSIONS (CM)	WIDTH	DEPTH	HEIGHT
A Unit <i>Base only</i>	83	83	45
A Unit <i>Bundled set*</i>	83	91	80
B Unit <i>Base only</i>	83	115	45
B Unit <i>Bundled set*</i>	83	123	80
C Unit <i>Base only</i>	115	115	45
Wide Arm	29	84	62
A Back	85	8	80
B Back	115	8	80
Cushion Boxed	60	60	10
Cushion Envelope	50	50	10

*Bundled Set - includes: 1 x A or B Unit, 1 x Back (Size A or B), 1 x V Connection Bracket (size A or B), 1 x Cushion - Boxed, 1 x Cushion - Envelope

ELEMENTS COMPONENTS

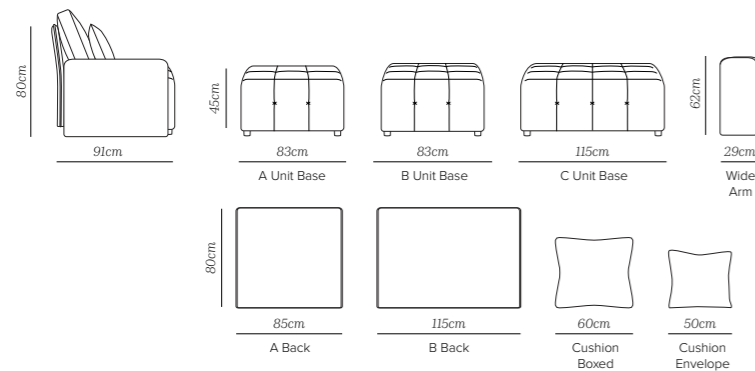

ELTON

The Elton is named after the singer known for his incredible style – and for backing the swagger with soul and substance. Here balanced proportions and gentle curves deliver an alluring sensuality and characteristic grace. The versatility of the design works in both commercial and residential settings, the footprint is built around a consistent radius, there's even the ability to create a full circle if you desire or use the two ends together for an intimate conversational nook. The solid framing and springing and superior cushioning comfort ensure both robust durability and lasting ergonomic support. Like the great artist the appeal of the Elton will last across decades.

DIMENSIONS (CM)	WIDTH	DEPTH	HEIGHT
End Unit (<i>LH/RH arm</i>)	165	85	80
Corner Unit	140	85	80
Straight Unit	109	85	80
OT21 Ottoman	115	115	37
Seat height			46

ELTON COMPONENTS

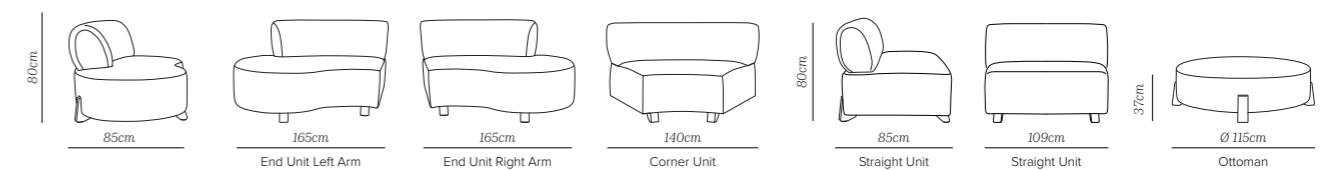

FREYA

Freya is an ensemble of timeless craftsmanship, where innovation and knowledge go hand in hand. Each contour and curve of this product range has been carefully designed to enhance the senses. Practical, elegant and supremely comfortable this collection is presented in a range of options maximising the ability to create the perfect combination to suit your special place. The Freya is a consummate choice for the discerning.

DIMENSIONS (CM)	WIDTH	DEPTH	HEIGHT
3 Seater Settee	196	96.5	90
3.5 Seater Settee	219	96.5	90
4 Seater Settee	242	96.5	90
End Unit Twin (LH/RH arm)	187	96.5	90
End Unit Single (LH/RH arm)	98	96.5	90
Straight Single Chaise (LH/RH chaise)	98	145	90
Straight Twin (no arms)	176	96.5	90
Straight Single (no arms)	89	96.5	90
Corner Unit	135	135	90
Seat height			49
Seat depth		58.5	
Seat depth Chaise		106	

FREYA SETTEES

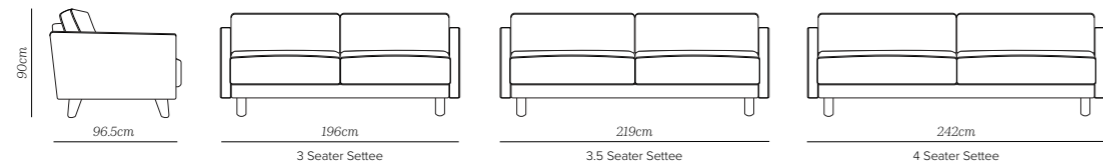

FREYA END UNITS / LEFT OR RIGHT ARM

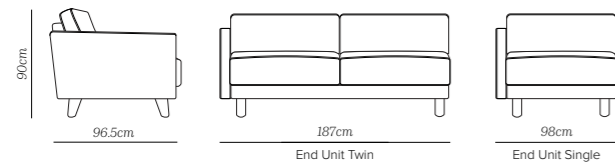

FREYA STRAIGHT UNITS

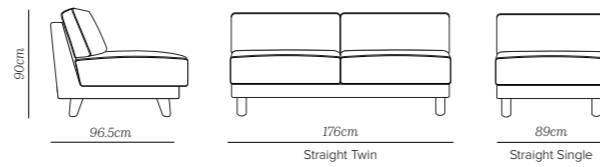

FREYA CORNER UNIT

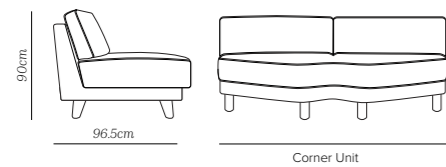

FREYA SINGLE CHAISE / LEFT OR RIGHT CHAISE

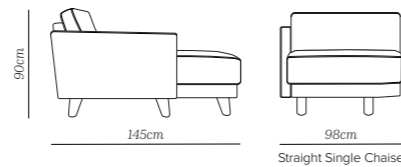

FREYA MODULAR LOUNGE

LENNOX

The Lennox has the leanest appearance of all our Kovacs settees, its slim-lined profile ensuring masterful efficiency and graceful comportment without compromising overall comfort in the slightest. Behind the back cushion the frame unfolds to create an adjustable headrest, maximising upper body support and increasing seating depth. The higher than normal seating makes it easy to sink in without struggling to rise. There's a lot going on beneath the surface too, the combination of steel, Southland beech, commercial grade foam and fibre fill ensuring a pitch-perfect end result – hour after hour of rewarding relaxation.

DIMENSIONS (CM)

Chair	96	95	87/105*
2.5 Seater	179	95	87/105*
3 Seater	205	95	87/105*
3.5 Seater	235	95	87/105*
Single Straight Standard (no arms)	75	95	87/105*
Single Straight Large (no arms)	86	95	87/105*
Twin Straight Standard (no arms)	148	95	87/105*
Twin Straight Large (no arms)	171	95	87/105*
Twin End Standard (LH/RH arm)	152	95	87/105*
Twin End Large (LH/RH arm)	174	95	87/105*
Twin End with Corner Standard (LH/RH arm)	240	95	87/105*
Twin End with Corner Large (LH/RH arm)	263	95	87/105*
Seat height		46	

headrest up*

LENNOX CHAIR AND SETTEES

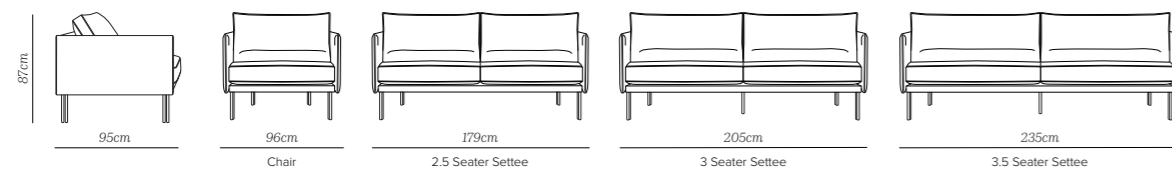

LENNOX END UNITS / LEFT OR RIGHT ARM

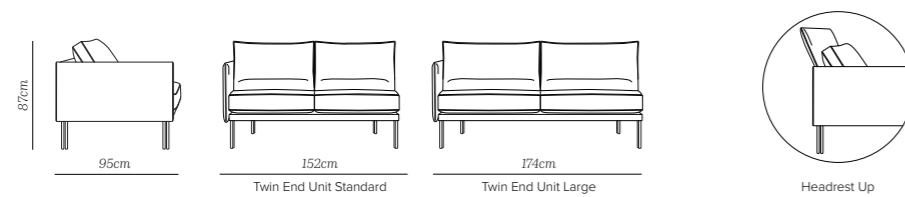

LENNOX END CORNER UNITS / LEFT OR RIGHT ARM

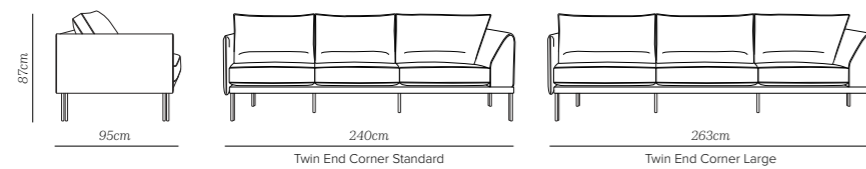

LENNOX STRAIGHT UNITS

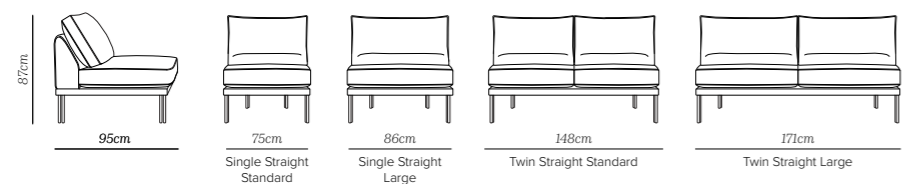

LENNOX MODULAR LOUNGE



MORGAN MODULAR LOUNGE
AND HUMPTY



MORGAN

Building on the success of an earlier model, the Morgan introduces a high back, thicker seat cushions and a new level of laminate foam for superior ergonomic support. The level of comfort is backed by solid, enduring design – it will look as good years from today as it does here and now. The adaptability of the Morgan is not limited to its settee or modular layout either. Create a fabric finish that is unique to your style. Change the arm placement to ensure efficiency of space. Choose the feet, contemporary metal 'stiletto' foot, brushed silver or black, or wooden peg leg, to step in sync with your space. Now available with removable body covers.

DIMENSIONS (CM)	
2 Seater Settee	
3 Seater Settee	
4 Seater Settee	
Straight Unit Twin (no arms)	
Straight Unit Triple (no arms)	
End Unit Twin (LH/RH arm)	
End Unit Triple (LH/RH arm)	
Chaise Unit Twin (LH/RH arm)	
Chaise Unit Triple (LH/RH arm)	
OT24 Ottoman	
Seat Height	

WIDTH	DEPTH	HEIGHT
182	95	82
248	95	82
315	95	82
135	95	82
202	95	82
159	95	82
225	95	82
215	95	82
281	95	82
68	95	44.5
		44.5

MORGAN SETTEES

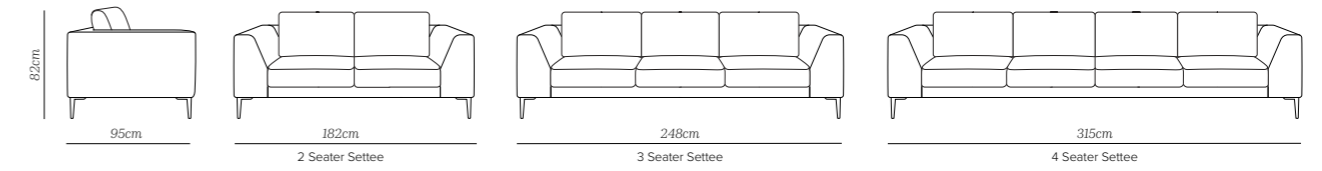

MORGAN END UNITS / LEFT OR RIGHT ARM

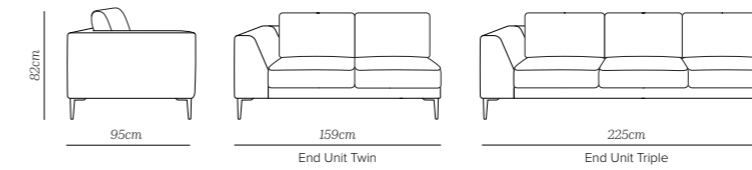

MORGAN CHAISE UNITS / LEFT OR RIGHT ARM

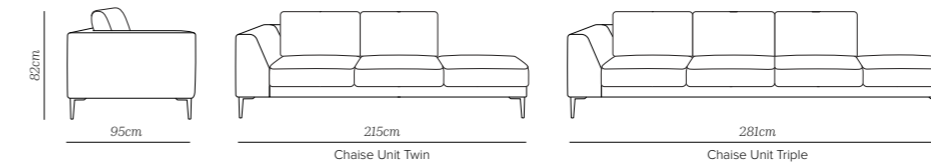

MORGAN STRAIGHT UNITS

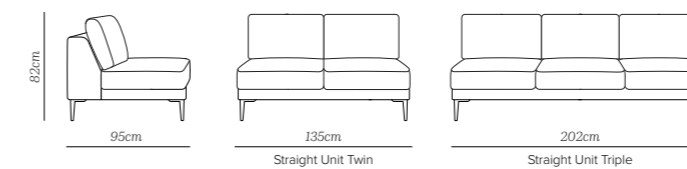

MORGAN OTTOMAN

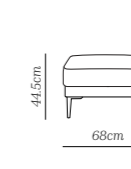



MORGAN MODULAR LOUNGE
AND HUMPTY

NEWPORT

The Newport offers a snug, stylish and sophisticated approach to modular seating, its chunky shape and careful construction prove pleasing on the eye and even more on the body. With its clear-cut European lines, compact footprint and flange detailing the couch can easily fit into a range of décor styles. The quality of comfort is considerable also. Here the mid-back height will support the shoulders without the design overpowering the room. The high quality foams provide firm support and the enticement to stretch out and slip into hours of serene relaxation.

DIMENSIONS (CM)

	WIDTH	DEPTH	HEIGHT
2.5 Seater	193	97	76
3 Seater	220	97	76
3.5 Seater	250	97	76
2.5 Seater End Unit Large (LH/RH arm)	168	97	76
3 Seater End Unit Large (LH/RH arm)	195	97	76
3.5 Seater End Unit Large (LH/RH arm)	225	97	76
End Unit Large (LH/RH arm)	109	97	76
End Unit Standard (LH/RH arm)	99	97	76
Corner Unit	97	97	76
Straight Unit Large (no arms)	84	97	76
Straight Unit Standard (no arms)	74	97	76
OT25 Ottoman Storage	65	97	46
Seat height			46

NEWPORT SETTEES

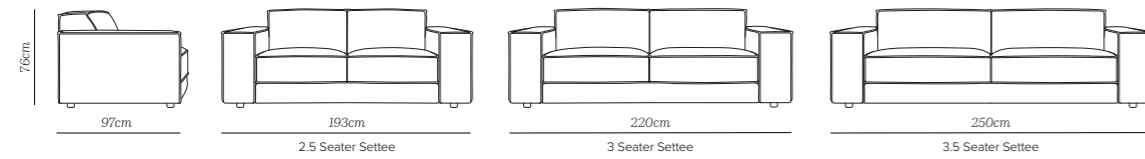

NEWPORT END UNITS / LEFT OR RIGHT ARM

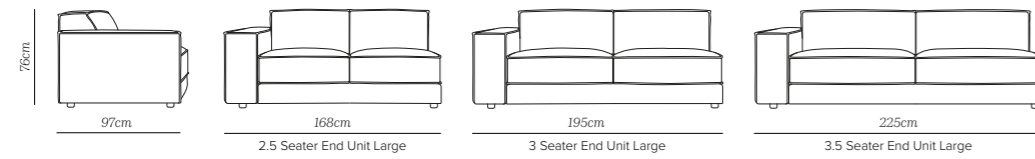

NEWPORT END UNITS / LEFT OR RIGHT ARM

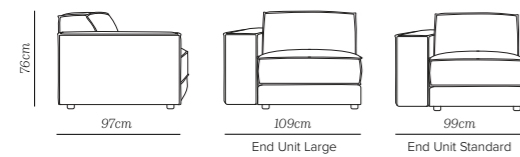

NEWPORT STRAIGHT UNITS

NEWPORT CORNER UNIT

NEWPORT OTTOMAN

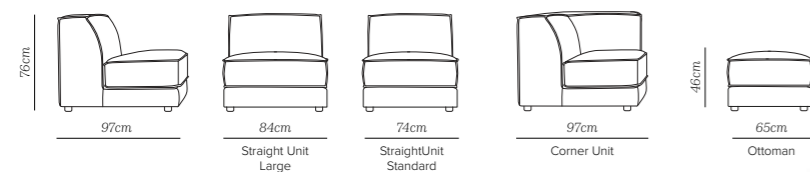

KOVACS
DESIGN FURNITURE

NEWPORT MODULAR LOUNGE
AND PARK-A COFFEE TABLE



CHAIRS

Our collection of New Zealand-made chairs echoes a design language that is broad and varied, ambitious yet pragmatic. With silhouettes ranging from fine minimal lines to plush confidence, and extensive finishes and fabric options to choose from, there are endless design possibilities for a seating solution that loudly proclaims both individuality and style.

BAXTER

Whimsical from some angles, serious from others, the Baxter is for those who appreciate the unexpected. The striking form uses two frames, each independent of the other. A solid beech external frame (with an option of oak) has a fine-grained texture providing an exquisite finish. The internal frame is constructed from MDF and beech, the strength and longevity of the latter timber ideal here. Careful consideration has also gone into the foam cushioning to support this frame. So, be it commercial or residential spaces, the compact Baxter is designed to create an impression. However, like all our furniture, it's to be enjoyed rather than just observed.

DIMENSIONS (CM)	WIDTH	DEPTH	HEIGHT
Chair	70	84	75
Seat height			44



DIESEL

The Diesel is available as both high and low back and, with fabric and leather finishes to suit your specific requirements. The Diesel doesn't have to try hard to impress with bold innovation or flashy gimmickry. Instead it does one thing, and does it well. If you don't believe everything that you read then simply take a seat and discover that thing. Ergonomically tailored, delivering comfort and support to hit all the right places, this is a chair that offers simple uncompromised luxurious rest and relaxation.

DIMENSIONS (CM)	WIDTH	DEPTH	HEIGHT
Chair - low back	72	75	85
Chair - high back	72	78	99
Seat height			47



high back

low back

BAXTER CHAIR

DUO

The Duo breast-feeding chair is a stylish contemporary design, purpose built in consultation with health professionals and experts in this field, and now used in most major hospitals throughout New Zealand. The chair offers extreme comfort and support, fully padded with high resilient seat foam which can be anti-microbial. Other features include; non-slip, retractable foot-tray which tucks away neatly when not in use, weighted lumbar cushion, heavy-duty hospital grade lockable rear castors and pusher handle.

DIMENSIONS (CM)	WIDTH	DEPTH	HEIGHT
Chair <i>Standard</i>	72	67	90
Chair <i>Xtra width</i>	82	67	90
Chair <i>Xtra large width</i>	92	67	90
Seat height			50



standard

xtra width

xtra large width

FRANKIE

The reasoning behind the name of this chair should become obvious when it's viewed alongside our popular Franklin model. While the Frankie has the distinctive style and well-padded comfort of it's bigger brother the lower profile, slimmer hind leg and compact footprint of this chair make it suited to a wider range of interior environments in both commercial and residential settings. With huge flexibility in fabric styles and small-but-confident charm this is a chair that can fit in or stand out, with a button look back or plain, both options have back arms top stitched – the choice is yours.

DIMENSIONS (CM)	WIDTH	DEPTH	HEIGHT
Chair	69	79	92
Seat height			47



plain back option 1

button look option 2

FRANKLIN

The Franklin's plush cushioning and structure offers an elegant solution to a huge variety of interior situations. Contemporary and ergonomically beneficial without being brazen or intrusive, it comes with the choice of a plain or button look seat back and a huge range of fabric finishing choices. With a small footprint this high-backed wing style delivers huge comfort and support for many different body types and the commercial grade foam and strong beech and MDF structure provide heavy-duty durability.

DIMENSIONS (CM)	WIDTH	DEPTH	HEIGHT
Chair	69	80	111
2 Seater	125.5	80	111
Seat height			48



button look option 2

plain back option 1



FRANKLIN CHAIR

LOUIS

The Louis chair has instant appeal for those who want the best blend of quality, comfort and contemporary design. There's durable frame construction, attention to detail and resilient seat foams, combined with a super web suspension system for supported seating. The Louis can be made up in either leather or fabric and the sturdy swivel stand base is standard in brushed stainless steel, with an option of a black base.

DIMENSIONS (CM)	WIDTH	DEPTH	HEIGHT
Chair	71	73	79
Seat height			45



MANTIS

The supple, curved and modular bearing provides encompassing support to the body and steel legs that echo the unique angles of the praying mantis - the Mantis swivel chair certainly has its contrasts. The art deco aesthetic delivers an edgy look and feel while offering simple functionality. The clean, angular lines and laser-cut steel foundation highlight aesthetic style while incorporating structural strength. Such striking design does not come at the cost of comfort or usability, with luxurious cushioning the Mantis encourages rest and relaxation.

DIMENSIONS (CM)	WIDTH	DEPTH	HEIGHT
Chair	64	70	72
Seat height			44



MARLEY

Balanced in its blend of strong lines and lenient curves, the Marley sits handsomely in a range of environments. From an office break-out seat to a sunny spot in a contemporary living room, this swivel chair could either be dressed to impress or styled to quietly merge with its surroundings. A round base and angular arms in powder coated metal lend balanced proportions with an unpretentious finish and a variety of colour options. A solid steel subframe gives the Marley the longevity to match its timeless form. Simple lines are at the heart of Marley's visual appeal, while a sprung seat enveloped in high density foam delivers the comfort which is synonymous with the Kovacs name.

DIMENSIONS (CM)	WIDTH	DEPTH	HEIGHT
Chair	71.5	77	74
Seat height			43



MUSE

Designed and crafted in accordance with our ideology of 'quality bound together with comfort and timeless style' the Muse chair hits the spot. A unique look, generous proportions and the promise of comfort. The powder-coated tubular steel frame provides a solid foundation and sleek appeal. The spherical shape of the back encompasses the upper body, while the spacious seat rounds out the experience. The Muse is an adaptable piece, integrating well and adding that special finishing touch to any surrounding.

DIMENSIONS (CM)	WIDTH	DEPTH	HEIGHT
Chair	83	76	71
Seat height			45



NERO

Simple, understated and classically elegant, the Nero chair is perfectly balanced with grace and strength. The durable seat has elasticised multi-strand webbing and the sturdy construction is enclosed with well-fitted covers and trim stitched detail. The legs are made of satin-polished silver beech.

DIMENSIONS (CM)	WIDTH	DEPTH	HEIGHT
Chair Long Leg	65	65	88
Seat height			49



SPYDER

It's been dubbed 'the little chair that will go anywhere' by our team. The Spyder works well with larger pieces or, with a bold colour or textured fabric, becomes a centerpiece in its own right. The elegant legs have a delicate appearance that belies their true strength. Constructed in welded steel, powder-coated and bolted on, they deliver a compact silhouette for the deceptively spacious seat. This adaptability is matched by comfort, which is a hall mark of all Kovacs product. Spyder now has an option of a matt black swivel base.

DIMENSIONS (CM)	WIDTH	DEPTH	HEIGHT
Chair	79	73	70
Seat height			43





TANGO CHAIR

TANGO

For those who are passionate about style and colour the design of the Tango dances to a different beat. It's backed by a solid stance too – the sturdy frame construction and resilient seat foam works well with the web seat suspension system to ensure lasting comfort. For a change in tempo the Tango can also be made in your choice of leather or fabric and the functionality of the swivel base ensures one never misses a thing.

DIMENSIONS (CM)	WIDTH	DEPTH	HEIGHT
Ground Swivel Chair	71	72	73
Seat height			45



TAYLOR

Ideally suited for small spaces the incredibly comfortable Taylor stands out with its unique style and design, providing both personality and functionality. The strongly built frame provides the structure supporting gentle internal & external curves resulting in both visual and physical harmony. With care in the design process the Taylor delivers the customers most crucial demand, a comfort that is both supportive and cosy. With tall square tapered timber legs the Taylor maintains a compact, funky demeanour, looking superb in a variety of fabric or leather finishes. This design sits well in both residential and commercial environments.

DIMENSIONS (CM)	WIDTH	DEPTH	HEIGHT
Chair	73	74	70
Seat height			45



TED

Introducing Ted, where 60's nostalgia meets contemporary flair. Embrace the funky curves that bring retro chic into the present. Ted rocks - literally - with a beautifully crafted wooden base that curves effortlessly. It's not just a chair, it's functional art, designed for comfort and elegance from every angle. Experience the allure of of minimal footprint and maximum style. The ply base is available in our standard stain colours.

DIMENSIONS (CM)	WIDTH	DEPTH	HEIGHT
Chair	73	82	73
Seat height			45



UNO

Extensively used in medical and healthcare environments. The chair-bed provides a solution for short-term support person or carer needs. Enabling them to rest and be present 24/7 with their loved ones. The locking castors enable users to quickly and easily move these units between rooms. Our inclusion of a hospital grade mattress means that the infection control requirements are adhered to.

DIMENSIONS (CM)	WIDTH	DEPTH	HEIGHT
Chair	102	84	101
Chair as Bed*	102	212	101
Seat height			47

*Not suitable for a person exceeding 120kg



ZOE

The bold lines and confident bearing of the Zoe makes it a great choice for the stylish modern home. Here, the extended back is both elegant and supportive – providing years of quality reading, conversation and relaxation time. Available as either a chair or two-seater, and with a high or low leg. A considered choice of leather or fabric also ensures the final look of the Zoe stands out with a solid, simple and effective design statement.

DIMENSIONS (CM)	WIDTH	DEPTH	HEIGHT
Chair - low leg	72	72	98/102.5*
2 Seater	141	72	98/102.5*
Seat height			45/49*
OT8 Ottoman	48	50	45 high leg*



TED CHAIR



KOVACS
DESIGN FURNITURE

ZOE CHAIR



MUSE CHAIRS AND
GEO SIDE TABLE



RANFURLY SETTEE

RECLINER LOUNGE

What should you look for in a good recliner lounge? We'd suggest, first and foremost, it must offer eye-catching style and feel-it-in-your-bones comfort. True relaxation only comes from expert design and the highest quality raw materials. True peace of mind only comes through careful tailoring and robust construction. You'll most likely spend many an hour in this furniture over the years – so make your investment count.

MERCEDES

Mercedes is designed for exceptional comfort with extra support for neck, shoulders and back. The chairs are available in four standard versions – a recliner, motorised recliner, 3D Motion mechanism that rocks, swivels and reclines and motorised Ezi-out lift chair – with a variety of features and options to customise the level of comfort you require. The cushioning material has been enhanced in key areas. Extra high density seat foam, with moulded body foam on top with the upright non-sagging back including extra lumbar support. A high back and optional adjustable headrest provide the ultimate in comfort fine tuning. Swivel castor and heavy-duty castor options add 25mm to seat height. Optional rechargeable battery power pack for motorised chair.



DIMENSIONS (CM)	WIDTH	DEPTH	HEIGHT
Chair - recliner*	78	95	104
Chair - motorised*	78	95	104
Chair - 3D**	78	95	104
Chair - ezi-out*	78	95	104
Seat height	49-53		

* Not suitable for a person exceeding 130kg
 ** Not suitable for a person exceeding 120kg

MURRAY

Minimalist and modern while evoking a classic feel of yesteryear, the Murray provides confident style and enduring, luxurious comfort – and it does so all within a conveniently compact footprint. Be it ordered as a fixed chair, a recliner or matching settees, in fabric or leather, the adjustable headrest, ergonomic support and enveloping luxury of this chair provides perfect stress-free seating. Optional rechargeable battery power pack for the motorised chair.



DIMENSIONS (CM)	WIDTH	DEPTH	HEIGHT
Chair - fixed	77	88	102
Chair - recliner*	77	88	102
Chair - motorised*	77	88	102
2 Seater	137	88	101
2.5 Seater	161	88	101
Seat height	46		

*Not suitable for a person exceeding 120kg

RANFURLY

The Ranfurly chair comes with a high back for supreme relaxation, and is available in three versions - a fixed chair, a recliner activated by a simple push or, a motorised recliner activated with a hand held remote control. The settee, available in a variety of options, brings a level of sophistication and glamour to any room. This series has eye-catching turned wooden front legs with a contemporary tapered front leg option also available. Optional rechargeable battery power pack for motorised chair.

DIMENSIONS (CM)	WIDTH	DEPTH	HEIGHT
Chair - fixed	105	93	101
Chair - recliner*	105	94	101
Chair - motorised*	105	94	101
2 Seater	162	92	94
2.5 Seater	192	92	94
3 Seater	221	92	94
OT12 Ottoman	57	50	46
Seat height	53		

*Not suitable for a person exceeding 120kg



SEDDON

The Seddon range is designed for maximum comfort within a compact footprint. The higher seating position and more upright stance suit people who like to remain attentive and active while seated. The chair can be fitted with a manual or a motorized recliner mechanism. Lockable heavy duty wheels can also be specified if required. Settees complete the range. Seat height varies with foot chosen. Optional rechargeable battery power pack for motorised chair.

DIMENSIONS (CM)	WIDTH	DEPTH	HEIGHT
Chair - fixed	75	87	110
Chair - recliner*	75	87	110
Chair - motorised*	75	87	110
2 Seater	134	87	104
2.5 Seater	158	87	104
Seat height	53		

*Not suitable for a person exceeding 120kg



SOME CLASSICS ARE BETTER UNPLUGGED.

That's why we're so happy we are now able to include the option of a battery pack* for our recliners. The chairs can perform up to 150 cycles on one charge, so it only needs to be plugged in for a quick recharge every now and then. This means you can now move chairs (and people) around the room for a change in scenery without the need for ugly extension cords to trip over.

*The battery pack is an optional feature and is available at an extra cost.





JED SETTEE AND
GEO COFFEE TABLE



GEO COFFEE TABLE



GEO TABLES

HARD FURNITURE

Whether tasked with adding structure or texture, the right coffee table, shelving unit or side table can deliver enticing smaller details while enhancing the bigger picture of any room. Here you'll find a range of wood and laminate finishes and, in powder-coated steel, a selection of colour ways. Whatever the brief, these carefully considered, Kovacs crafted designs will prove up to the task.

BRUNA

With off-beat layers and abstract geometry, Bruna shelving adds vertical interest to an interior without dominating it. Freestanding on a steel base, it can sit pretty as a wall piece or confidently divide and define sections of a room. The fine lines and liberal spacing of the design allow light and movement to flow freely, maintaining a visual connection between two spaces.

DIMENSIONS (CM)	WIDTH	DEPTH	HEIGHT
Shelving Unit	151	43	198



GEO

With a slender profile and subtle strength the Geo collection offers equal parts everyday usability, year-round adaptability, and enduring sophistication. These NZ-made tables are available in a selection of shapes, heights and materials. Crafted from wood, steel and stone, by request, opportunity abounds to seek out the ideal style for any setting. United in form by a square tubular steel base and an elegant cross-brace support, the collection is designed and built to be both light and strong. Use of layers of laminated plywood beneath the surface add strength and style. The slim look is achieved through a 45° recessed edge, making the view unique and memorable.

DIMENSIONS (CM)	WIDTH	DEPTH	HEIGHT
Coffee Table Oblong	70	130	38.5
Coffee Table Square	97	97	38.5
Small Side Table Square	44	44	49.5
Coffee Table Circular	97	97	38.5
Side Table Circular	47	47	49.5





HUMPTY COFFEE TABLE

HUMPTY

It's not just a well-balanced table or convenient resting place. The Humpty can also double as extra seating, making it ideal for those 'last minute arrival' occasions when finding enough seats becomes a challenge. When not required these can be neatly tucked away under the coffee table, saving space and setting the scene. The Humpty can be purchased individually or as a set of four with the table in two sizes.

DIMENSIONS (CM)	WIDTH	DEPTH	HEIGHT
OT9L Humpty <i>Large</i>	57	57	35
Coffee Table <i>Large</i>	116	116	42
OT9S Humpty <i>Small</i>	46	46	35
Coffee Table <i>Small</i>	95	95	42



MASON TABLES

Providing natural texture to a setting without bulk, the warm timber and slender steel frame assures strength while maintaining a sleek profile. With two wooden finishes available - 30mm crown cut oak veneer with edge banded sides or 6mm solid European oak laminated onto 24mm ply. Enquire about the variety of stone options available - from polished, honed or leathered finishes. Available in a range of sizes, the Mason stands out while still allowing other pieces within the room to breathe.

DIMENSIONS (CM)	WIDTH	DEPTH	HEIGHT
Coffee Table Circular	97	97	38
Coffee Table Circular <i>Large</i>	105	105	38
Side Table Circular <i>Large</i>	60	60	45
Side Table Circular <i>Medium</i>	47	47	45



PARK-A TABLES

The Park-A series both lifts and anchors a room with its simplistic yet strong form, available in coffee tables, console tables and side tables. Made entirely in our New Zealand factory, and with two wooden finishes - 30mm crown cut oak veneer with edge banded sides or 6mm solid European oak laminated onto 24mm ply held within a solid steel bar framework. This steel is practical and uncompromising and yet, with its sleek lines and minimalist joins, altogether elegant and light in bearing. To reference its name the Park-A has the option of an engraved 'parquet' pattern to the table surface (not available on Side Table 02).

DIMENSIONS (CM)	WIDTH	DEPTH	HEIGHT
Console Table 01	185	42	70
Console Table 02	160	42	70
Coffee Table Oblong 01	119	61.5	38
Coffee Table Square 02	119	119	38
Side Table 01	61.5	61.5	38
Side Table 02	39.5	39.5	56





NEWPORT SETTEE, GEO
SIDE TABLE AND DUMPTY

OTTOMANS

There's a lot to be said for the perfectly placed ottoman. From the cool and sensible to those that command more of a presence, we craft these pieces to sit comfortably and confidently in any setting. Don't settle for inferior quality furniture. Now is time to create your ottoman empire.



ENZO ROUND PLAIN OTTOMAN

BROOKLYN

DIMENSIONS (CM)	WIDTH	DEPTH	HEIGHT
OT20 Brooklyn	110	70	40



DUMPTY

DIMENSIONS (CM)	WIDTH	DEPTH	HEIGHT
OT19 Dumpty	42	42	38

Available detailed in leather or plain in fabric



ELTON

DIMENSIONS (CM)	WIDTH	DEPTH	HEIGHT
OT21 Elton	115	115	37

Available buttoned or plain



ENZO ROUND

DIMENSIONS (CM)	WIDTH	DEPTH	HEIGHT
OT11 Enzo round	106	106	31

Available buttoned or plain



HUMPTY

DIMENSIONS (CM)	WIDTH	DEPTH	HEIGHT
OT9L Humpty Large	57	57	35
Coffee Table Large	116	116	42
OT9S Humpty Small	46	46	35
Coffee Table Small	95	95	42



JED

DIMENSIONS (CM)	WIDTH	DEPTH	HEIGHT
OT22 Jed small	71	65	43.5
OT23 Jed large	95	68	43.5



LOOP

DIMENSIONS (CM)	WIDTH	DEPTH	HEIGHT
OT17 6 Legs Long	152	45	44
OT17G Glide Long	152	45	31
OT18 4 Legs Short	100	45	44
OT18G Glide Short	100	45	31



MORGAN

DIMENSIONS (CM)	WIDTH	DEPTH	HEIGHT
OT24 Morgan	68	95	44.5



NEWPORT

DIMENSIONS (CM)	WIDTH	DEPTH	HEIGHT
OT25 Newport	65	97	46

Available fixed or storage.



RANFURLY

DIMENSIONS (CM)	WIDTH	DEPTH	HEIGHT
OT12 Ranfurly	57	50	46



ROX

DIMENSIONS (CM)	WIDTH	DEPTH	HEIGHT
OT26 Rox	60	60	37



ZOE

DIMENSIONS (CM)	WIDTH	DEPTH	HEIGHT
OT8 Zoe	48	50	45



The Kovacs Custom Range comes with a choice of two standard shapes, oblong and square, they can be constructed in fixed or storage and also provide the option of a deep or shallow profile. These ottomans can be adapted for flexibility of style too. Depending on the choice of leg you can customise the height of your ottoman or match it to an existing suite.

**Height shown here is furnished height so add the height of your chosen leg for overall height.*

OBLONG

DIMENSIONS (CM)	WIDTH	DEPTH	HEIGHT
OT1 Oblong	155	66	42.5*

Available fixed or storage.
Add chosen leg for overall height.



OBLONG SHALLOW

DIMENSIONS (CM)	WIDTH	DEPTH	HEIGHT
OT2 Oblong shallow	155	65	29*

Available fixed or storage.
Add chosen leg for overall height.



SQUARE SHALLOW

DIMENSIONS (CM)	WIDTH	DEPTH	HEIGHT
OT4 Square shallow	97	97	29*

Add chosen leg for overall height.



Our wooden legs can be stained in a variety of colours. Please see website for options.

KOVACS
DESIGN FURNITURE



LOOP OTTOMAN

FOR TOMORROW. OUR ENVIRONMENTAL RESPONSIBILITY.

We continuously strive to make improvement in our sustainable practise, ensuring the lowest possible environmental impact and long-term positive results for our business and for our customers. We are always looking at new ways to positively shape tomorrow, this mind-set is focused, our resolve unwavering.

MATERIAL STRENGTH

We always champion the use of sustainable wool instead of artificial fibres in our furniture, a natural choice that markedly reduces our carbon footprint. We also use water-based solvent-free adhesives that have no environmentally harmful VOCs. We are continuously working to minimise and eliminate plastics within our manufacturing processes.

WOOD FOR THE TREES

Kovacs frames are predominantly made from indigenous silver beech from Southland's natural and second-growth forests. These privately owned forests must prove that they are managed to precise standards as part of a detailed and long-term sustainability plan. This involves the forestry gaining a Ministry of Agriculture and Forestry approved Sustainable Forest Management (SFM) Plan or SFM Permit.

REDUCING AND MANAGING WASTE

During manufacturing various measures are taken to ensure the environmental management of all waste materials. Wood working machines are equipped with vacuum sawdust collecting facilities, scrap metal is collected and is recycled where possible, and packaging materials are reduced, carefully sorted, and quickly recycled. Both foam and wool waste is returned for recycling.

THE JOURNEY TO YOU

We are always looking to minimise and mitigate environmental impact as Kovacs furniture makes its way to you. There are many ways the logistical processes involved with packaging and shipping can be positively influenced – and we're seeking to evolve and improve our work here.



WHY DO WE USE NEW ZEALAND WOOL IN KOVACS FURNITURE? IT'S ABOUT SIMPLE COMMON SENSE AND OBVIOUS NATURAL STRENGTHS.

Humans have used wool since approximately 10,000 BC for good reason. The highly breathable and remarkably flexible material is resilient, fire-resistant, and, as long as there are sheep here in New Zealand, absolutely renewable.

While there are many alternatives in the modern era, the enduring capabilities of wool make it ideal for use as padding material in quality furniture. Its resilience and elasticity means it will bounce back quickly and easily when pressure is applied and, similar to its performance for clothing, it also has the ability to regulate temperature.

Sourced from Kiwi suppliers who share our ethos of quality, sustainability, and community, we offer wool products as an option for many of our models.

Be it providing a felted buffer between springing and foam, acting as a soft protective layer between foam and fabric, or as an internal fill for cushioning, this wool takes many different shapes. There's loose crimped wool or wool knops as an alternative to polyester fibre, and needled wool sheeting (ranging from 350 gram through to a 750 gram sheeting that resembles felt).

At Kovacs we are proud to support local industry and championing NZ wool is part of this evolutionary process of constantly striving to improve our product making it the best it can be.

IN 1959 KOVACS FIRST BEGAN MAKING FURNITURE IN CHRISTCHURCH, NEW ZEALAND.

The story behind our company is one that crosses the globe. Weary from the hardship and scarcity of post-war Hungary, Stephen and Maria Kovacs sought a better life. Their path took them first to neighbouring Austria for two years and then, after qualifying as refugees, across the world to New Zealand.

Stephen is pictured back row, third from the right.

In Christchurch the young couple were amazed to discover people living in comparative freedom and wealth. Stephen found work at a local upholstery firm and Maria, pregnant with their first child, cycled kilometres to work each day, where she made handbags.

There was undoubtedly some culture shock. Stephen quickly realised he was doing the work of two men and, when asking for a raise, was told to slow down to the pace of the others. Instead, he turned his focus elsewhere and began making furniture in his garden shed over the weekends.

Demand was increasing for his hand-crafted pieces, and he looked for a commercial premises. With no small amount of raw ambition, a passion for knowledge and tenacious hard work, Kovacs Furniture was born.

The effort and expertise were soon rewarded. In just a few years the company had over 20 staff, and Stephen and Maria's two children, Hildy and Johnny, were fast growing up within the world of furniture design and manufacturing. After completing university study each joined the company.

The Kovacs parents provided an invaluable base of knowledge to set each child on their respective career paths, their engineering acumen, artistic knowledge, and design craft fuelling the business for the decades to come.

Johnny and Hildy's burgeoning skills were matched by an equally talented team and together the Kovacs team have met every challenge over the years. Sometimes these have been personal, with Stephen passing away in 1993, and Maria in 2016. In others it has been professional, be it the impact of the 2011 earthquake on the Ferrymead building, or the considerable disruption of the pandemic years.

The removal of import tariffs and subsequent deluge of low-cost, lower-quality furniture in the early 2000s resulted in the closure of many New Zealand furniture makers. It also provided an opportunity for quality in design and craft to step up.

The tight-knit family environment here has persisted to present day, as have the other important traits that Kovacs first started with.

Our close supplier relationships, carefully forged over these years, means we source materials from companies that parallel our values and devotion to quality. Our commitment to sustainable practises has elevated output without compromising integrity. New technologies and materials are balanced with old-fashioned European artisanship, ensuring innovation never comes at the cost of authenticity.

The popularity of our furniture has continued to grow too, particularly as more people recognise how passion and care in design, craft, and construction delivers enduring comfort and timeless design. And that's the difference of each and every Kovacs piece. It is crafted by hand, known by heart, and made right here.

65
Years

**MADE.
RIGHT.
HERE.**

INDEX

11 LOUNGE

- 11 Axle
- 11 Brooklyn (10)
- 13 Club (12)
- 13 Gibbston (14-15)
- 13 Grace
- 19 Heath (18)
- 19 Hendrix (16-17)
- 19 Henley
- 20 Jed (70-71)
- 20 Jigsaw (22-23)
- 20 Lincoln (4-5)
- 21 Loft
- 21 Max
- 21 Simplicity (24-25)

27 MODULAR LOUNGE

- 28 Bertie (8-9, 26-27, 28-29)
- 30 Bronte
- 34 Bronx (front cover, 32-33, 90-91)
- 38 Combi (36-37)
- 39 Detroit
- 40 Elements
- 41 Elton
- 42 Freya (2-3, 43)
- 44 Lennox (6-7, 45)
- 48 Morgan (46-47, 50-51)
- 52 Newport (53, 78-79)

47 CHAIRS

- 55 Baxter (54)
- 55 Diesel
- 56 Duo
- 56 Frankie
- 56 Franklin (57)
- 58 Louis
- 58 Mantis (back cover)
- 58 Marley (8)
- 59 Muse (64-65)
- 59 Nero
- 59 Spyder
- 61 Tango (5, 60)
- 61 Taylor
- 61 Ted (62)
- 62 Uno
- 62 Zoe (63)

60 RECLINER LOUNGE

- 68 Mercedes
- 68 Murray
- 69 Ranfurly (66-67)
- 69 Seddon

75 HARD FURNITURE

- 75 Bruna (16-17)
- 75 Geo Tables (front cover, 2-3, 4-5, 16-17, 22-23, 24-25, 32-33, 64-64, 72-73, 74)
- 77 Humpty (46-47, 48, 76, 78)
- 77 Mason Tables (8, 14-15, 18, 26-27, 41)
- 77 Park-A Tables (40, 53)

80 OTTOMANS

- 81 OT20 Brooklyn
- 81 OT19 Dumpty (57, 79)
- 81 OT21 Elton
- 81 OT11 Enzo (80)
- 81 OT9 Humpty (46-47, 48, 76, 78)
- 81 OT22, OT23 Jed
- 81 OT17, OT18 Loop (83)
- 81 OT24 Morgan
- 81 OT25 Newport
- 82 OT12 Ranfurly
- 82 OT26 Rox (front cover, 6, 32, 91)
- 82 OT8 Zoe
- 82 OT1 Oblong
- 82 OT2 Oblong - shallow
- 82 OT4 Square - shallow

Special thanks to Lighthouse Lighting for accessories on pages 2-3, 10, 18, 22-23 & 54.

WHERE TO PURCHASE

STOCKISTS

In this age of fast fashion and 24-hour delivery many people make the mistake of buying before trying. A well-made piece of furniture is an investment you shouldn't leave to chance.

Throughout the country our stockist network provides the best way to get up close and personal with Kovacs design. We don't sell just anywhere either. Kovacs has carefully forged partnerships with like-minded businesses over the decades – those who share our values for quality furniture designed, constructed and loved in New Zealand.

This network is trusted to deliver quality service and helpful insight. A suitable selection of pieces ensure you can undertake proper testing of a desired piece, seeing how construction and craftsmanship can make such a difference to both style and comfort.

When you need to experience the difference between temporary 'fast furniture' and that which is made for the decades ahead, scan the QR code below to find a Kovacs stockist near you.



Scan here to find a stockist near you:

kovacs.co.nz/stockists/

INTERIOR DESIGNERS

A good interior designer will help you craft a cohesive and well-considered aesthetic that matches your look and your lifestyle. A great interior designer will make sure your ideal functionality and style endure year after year.

It's safe to say that we work with some truly great designers. They have the fabric choices, the spatial insight, the depth of experience and expertise that can truly elevate a room. And, while they may have impeccable personal taste, they don't let specific preferences and trends get in the way of finding the right furniture for your needs.

They also have access to Kovacs showrooms in Auckland, Wellington and Christchurch, where they can help you get up close with a range of quality pieces. The difference can be between finding something you'll love here and now, and something you'll cherish across the years ahead.

If you already have an interior designer, we are happy to work with them to ensure your furniture is uniquely yours. If you'd like to connect with a talented interior designer, we can help you find one. Scan the QR code below to get in contact.



Scan here to go to our contact page:

kovacs.co.nz/contact/



**MADE.[®]
RIGHT.
HERE.**



KOVACS.CO.NZ

® Registered Trademark of Kovacs Design Furniture Limited

KOVACS

DESIGN FURNITURE



VOLUME 04